

ROTARY TELESCOPIC HANDLERS

TR SERIES

Europe



One Tough Animal®

INTRODUCTION

ONE TOUGH ANIMAL



BOBCAT'S HISTORY

In 1958, Melroe Manufacturing Company introduced a compact front-end loader that evolved quickly into the M400, the world's first true skid steer loader. The company soon adopted what became the world-famous 'Bobcat' brand – and its success paved the way for the global compact equipment industry we know today.

NEVER-ENDING INNOVATION

New technologies and machines are rigorously tested in our innovation facilities to take on the toughest jobs.



BOBCAT TODAY

Bobcat rotary telescopic handlers are equipped with the latest advanced technologies to help you work efficiently, safely and with unbeatable comfort.



OUR MISSION

We empower operators to accomplish more, while working in the toughest conditions and tightest situations. When our customers have the will, we provide the way.

BUILT TO PERFORM AT 360°

► POWERFUL AND STABLE

By adding cutting-edge technology to Bobcat's rotary telescopic handlers, we have created the ultimate tool for even the most complex handling jobs. Working at height has never been so efficient, comfortable and safe.



R.F.ID automatic attachment recognition system

A wide range of attachments to excel in a variety of applications in handling, lifting and people elevation.

High-tensile steel boom structure with hoses protected inside

Cab certified FOPS & ROPS

Combined hydraulic functions (Load Sensing pump with Flow sharing)*

Pressurized cab & 100% air filtration

24V electric system IP67 rated & CAN-Bus system

Control panel with large touchscreen & jog shuttle

360° continuous rotation turret*

Telematic system

Air conditioning as standard*

Oscillating rear axle with self-hydraulic locking

Frame levelling +/- 8°

Stage 5 engine Automatic engine speed adjustment to supply hydraulic power required.

Powerful variable hydrostatic transmission with heavy-duty oil immersed axles

3 steering modes with semi-automatic realignment

Smart stabilizers with a range of advanced features such as: low ground pressure, auto-leveling, load chart adjusted to stabilizer extensions, stabilization area memorized and retraction cushioning.

Automatic parking brake

*except TR40.180



► COMFORTABLE

The cab's innovative design and standard features deliver unbeatable operator comfort and great visibility.

P.8



► INTUITIVE

An operating station designed for the operator. All information and machine settings are logically grouped together in a large touch screen.

P.20



► VERSATILE

Enjoy a wide range of attachments for a variety of tasks, optimized for maximum performance.

P.19



► SAFE & PERFORMANT

Automatic attachment recognition and Dynamic load chart loaded on the screen give you total control of the situation.

P.9

UNBEATABLE CAB EXPERIENCE



► FIRST-CLASS COMFORT
Step into the air-conditioned*, heated, airtight and fully pressurized innovative cab with 100% air filtration and enjoy the giant, unobstructed windshield for unmatched safety and visibility.



► ROOF GRID BLADES



ROPS/FOPS cab protection designed to enhance visibility when lifting in top height.

► EVERYDAY ERGONOMICS



Get in and out of the cab with ease thanks to a quickly adjustable steering column with pedal.

► INTUITIVE OPERATION



Stabilization and frame leveling controls are grouped together on the console along the side window.

*except TR40.180

DESIGNED FOR SAFETY

► SECURED WORKING AREA

The limit page allows the operator to secure the working area by setting virtual walls on each side, in front and overhead. If need be, you can also adjust all boom and rotation speeds.

► ATTACHMENT RECOGNITION SYSTEM

The machine automatically recognizes the attachment being paired using RFID technology and uploads the corresponding load charts onto the display. You are ready to work safely within seconds.



DESIGNED FOR PERFORMANCE

► INTELLIGENT STABILIZATION

Optimized stabilization performance thanks to ground pressure detection, one-button auto-leveling and a self-adapting working envelope to set the lifting capacity for each stabilizer independently.

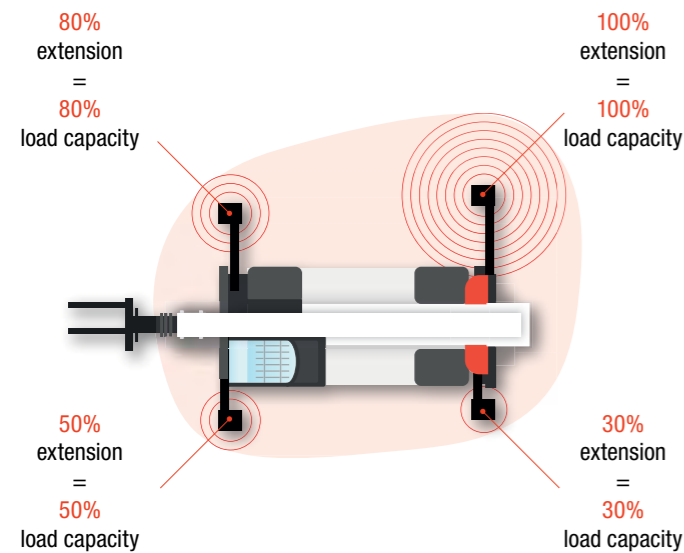

► SMART OPERATION

From its very first movements, the machine's electronic management takes over and automatically adjusts the engine speed and the load-sensing hydraulic system. So, you can stay focused on your Number 1 concern: Doing your job with precision and in complete safety.



STRONG AND RELIABLE

► BUILT TO LAST

Designed to withstand the toughest construction jobs thanks to a welded monobloc frame, hydraulic hoses completely contained inside the boom and heavy-duty axles. Manufactured from high-tensile steel, the boom is extremely tough and rigid but at the same time very light, increasing the load capacity and preventing it from flexing.

► PROTECTED FROM ELEMENTS

The 24V electric circuit has IP67-rated protection from water and dust entry, while Bobcat's CAN BUS technology means a 30% reduction in wiring, further increasing reliability.



► MACHINE TELEMATIC

Machine Telematic enhances the support for your Bobcat machine.

- Durable built-in monitoring electronics
- Data is available to our machine monitoring specialist
- Maintenance is optimized for your business
- Data-driven services maximize uptime

► STANDARD WARRANTY

Bobcat Company develops every machine to the highest standards of quality and durability. That's why our standard warranty provides 24 months or 2000 operating hours (whichever occurs first) of coverage.

THERE'S NO TIME FOR DOWNTIME. STAND UP TO THE HARSHTEST CONDITIONS. DAY AFTER DAY.



► PROTECTION PLUS EXTENDED WARRANTY

Enjoy total peace of mind with Protection Plus® extended warranty. Providing the same level of protection as the standard warranty, Protection Plus also reflects different customer needs and expectations by offering a choice of durations and annual operating hours. According to your needs, you can benefit from the coverage for up to 5 years or 5 000 engine hours. And Protection Plus is transferrable – so it will likely increase your machine's resale value.



► BOBCARE

A long-running machine starts with proper planned maintenance - which helps protect against repair costs and unplanned failures when you're counting on your machine to work.

- Avoid risk by preventing major repairs and complete failures.
- Accomplish more by reducing downtime and increasing your productivity and profitability.

CHOOSE YOUR ANIMAL

PIVOTING STABILIZERS

► SIMPLY EFFECTIVE

Find the perfect machine among 4 models with easy to deploy stabilizers, lifting height between 18-25 m and maximum lifting capacity between 4-5 tons.

► AVAILABLE MODELS

- TR40.180
- TR50.180
- TR50.210
- TR50.250



SCISSOR STABILIZERS

► CUSTOMIZED STABILIZATION

Choose from 6 models with powerful, versatile telescopic scissor stabilizers with higher ground clearance, allowing 21-39 m lifting height and a maximum lift capacity between 6-7 tons. Featuring several types of stabilization, such as compact, partial or full (to obtain maximum working envelope) and load charts adapted to the position of each stabilizer.

► AVAILABLE MODELS

- TR60.210
- TR60.250
- TR70.260
- TR60.300
- TR60.350
- TR60.390



STANDARD EQUIPMENT

OPTIONS



TR60.250 running on Twin Power – fully electric engine

STANDARD EQUIPMENT

- Quick fit carriage with manual attachment lock
- Pallet fork frame floating, 1.3 m wide, forks included
- Auxiliary hydraulic line on boom head
- Automatic RFID attachment recognition system
- Man platform ready
- Winch ready
- Towing hook
- Frame leveling +/-8°*
- Complete road lights (front & rear)
- Right and left side mirrors
- Cab with full glass door
- Full tinted glass
- Pressurized cab, 100% air filtration
- Automatic parking brake
- Roof window wiper
- Front wipers with washer
- Rotating beacon
- Adjustable steering column
- Heating, demisting and ventilation
- Air conditioning (HVAC)*
- Back-up alarm
- Bluetooth radio, microphone & loudspeakers
- Mechanical suspension seat
- Touch screen
- Jog shuttle
- 2 multifunctional joysticks
- 24 V electric socket
- Battery disconnection
- Telematic system

*Except on TR40.180

PERSONALIZE YOUR MACHINE

Sometimes, we all want to add a specific functionality or a personal touch to the machine. Choose from a comprehensive list of options and customize your rotary telescopic handler to your heart's content!



Front view camera

Rear view camera

Remote control with display and remote drive



Camera display

Hydraulic attachment lock

High comfort air suspension seat with headrest



LED work lights

Stabilizers' plastic pads

Ladder



Wheel wedges

Sun visor

Radio DAB



Twin Power

FOR ALL MODELS

- 110/220 Volt plug at boom head
- Additional heater in cab (Eberspächer)
- Air conditioning (HVAC)*
- Anti-spark system
- Bio hydraulic oil
- Boom suspension
- Custom color
- Double or triple hydraulic output at boom head
- Engine coolant heater
- Heated rear view mirrors (all) 24 V
- Heated seat 24 V
- High comfort air suspension seat
- Seat headrest
- Hydraulic attachment lock
- Hydraulic oil for cold climate
- Hydraulic oil heater
- Hydraulic trailer brake
- Hydraulic turret rotation lock
- Ladder
- LED work lights
- Protective grill for windshield
- Radio DAB
- Remote control
- Road tires 445/65R22.5" with mudguards
- Stabilizers' plastic pads
- Sun visor
- Tool box
- Twin power (full electric working mode)
- Video camera with display (1 or several cameras)
- Wheel wedge (x2)

VERSATILITY

▶ THE ABILITY TO DO MORE

Bobcat Rotary telescopic handlers are designed to excel in a variety of applications in handling, lifting and people elevation. With Bobcat attachments, you can make the most of this versatility with optimal efficiency.

▶ MAN PLATFORMS



Extendable rotating platform equipped with a winch, 500 kg payload / 3 people



Roofer Extendable rotating platform with 1 000 kg payload / 3 people



Extendable rotating platform with 500 kg or 1 000 kg payload / 3 people

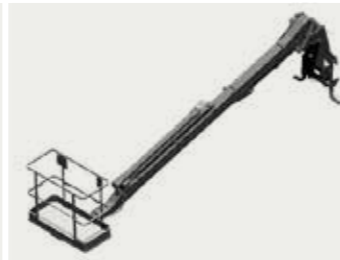

Fixed telescopic platform with 200 kg payload / 2 people

▶ HOOKS, JIBS, WINCHES



Crane jibs



Winches



Extension jibs



Jibs with winch

▶ BUCKETS



Light material bucket



Waste bucket

▶ PALLET FORKS



Floating pallet fork frames



Rotating pallet fork frame



ADVANCED CONTROLS

▶ SMART AND INTUITIVE

See and control everything important on the large touchscreen which comes as standard. Navigate smoothly between 5 pages of the menu using touch or the jog shuttle.

▶ DRIVE PAGE



This page contains all driving information, steering modes, and monitors all vital information.

▶ STABILIZATION PAGE



Control all 4 stabilizers simultaneously or independently and check their position at a glance. If they are in contact with the ground, the automatic leveling system makes it easy and quick to set up.

▶ WORK PAGE



The work page displays the paired attachment which is recognized automatically by the R.F.ID system. A dynamic load chart shows the load moving following the telescopic boom movements. The operator can quickly read the actual load weight and check the maximum lifting capacity in this position.

▶ LIMIT PAGE



The limit page allows the operator to secure the working area by setting virtual walls on each side, in front and above. If need be, the operator can also adjust all boom and rotation speeds.

▶ CONTROL PAGE



All utility controls on one screen: ventilation, heating, AC, lights, remote radio control, turret lock, etc.



SPECIFICATIONS

SPECIFICATIONS	TR40.180	TR50.180	TR50.210	TR50.250
PERFORMANCE				
Rated capacity at 500 mm load center	4 000 kg		4 999 kg	
Max. lifting height (stabilizers fully extended)	17.56 m		20.50 m	24.60 m
Turret rotation	+/-200° (limited)		360° (continuous)	
Frame levelling	-		+/- 8°	
Max. speed	25 km/h		40 km/h	
STABILIZERS				
Type	Pivoting stabilizers			
Stabilization system	Ground pressure detection. Automatic levelling.			
ENGINE				
Deutz TCD 3.6 L4 - 55 kW (75 HP) - Stage V	•			
Deutz TCD 3.6 L4 - 100 kW (134 HP) - Stage V		•	•	•
HYDRAULIC SYSTEM				
Pump type	Gear pump		Load Sensing pump	
Pump capacity	70 l/min at 270 bar		105 l/min at 350 bar	
Control valve (boom and turret)	Electro-proportional with flow sharing			
DRIVE SYSTEM & STEERING				
Transmission	Hydrostatic with electronic regulation / 4 wheel drive			
Main drive	Electronically controlled variable displacement pump. Variable displacement motor. 2-speed gear box			
Steering modes	3 steering modes with semi-automatic wheel realignment. 2 wheel steering / 4 wheel steering / Crab-steer			
DIMENSIONS & WEIGHT				
Overall length at fork face	6.79 m	6.69 m	6.57 m	7.62 m
Overall width at tires	2.54 m		2.55 m	2.54 m
Overall height at roof wiper	3.11 m		3.12 m	
Stabilization area (stabilizers fully extended)	5.06 × 4.27 m			
Standard tires	445/65 R19.5		445/65 R22.5	
External turning radius	4.13 m		3.82 m	3.99 m
Weight (unladen)	14 400 kg	15 100 kg	15 900 kg	16 600 kg
FLUID CAPACITIES				
Fuel tank		175 l		
AdBlue		10 l		
Hydraulic reservoir		165 l		

Certain specification(s) are based on engineering calculations and are not actual measurements. Specification(s) are provided for comparison purposes only and are subject to change without notice. Specification(s) for your individual Bobcat equipment will vary based on normal variations in design, manufacturing, operating conditions, and other factors. Pictures of Bobcat units may show other than standard equipment.

LOADCHARTS

TR40.180

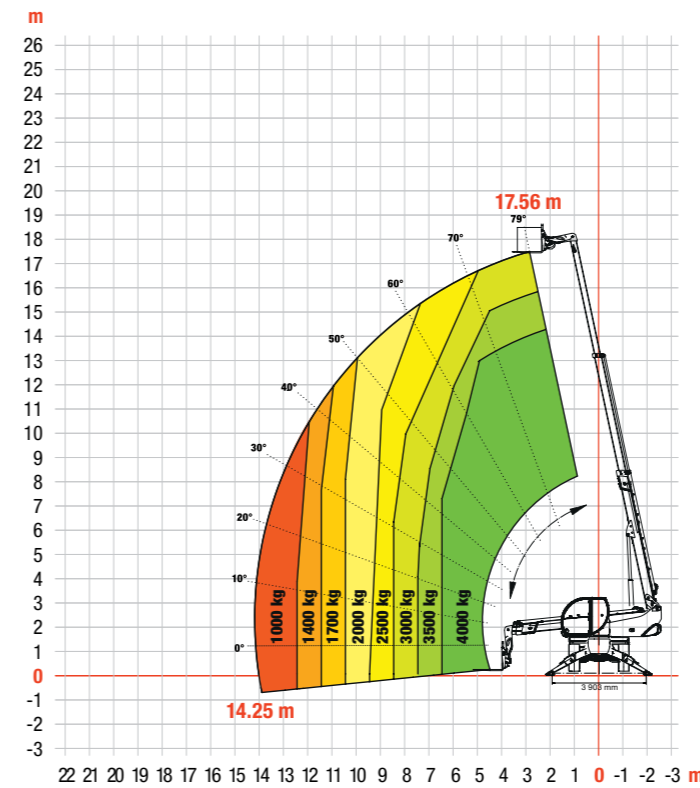

TR50.180

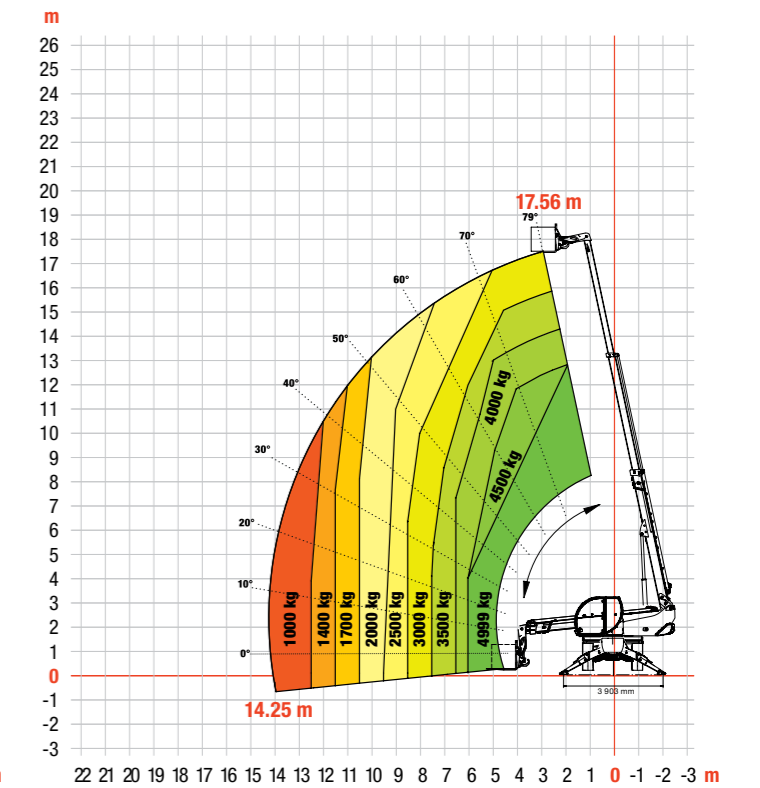

TR50.210

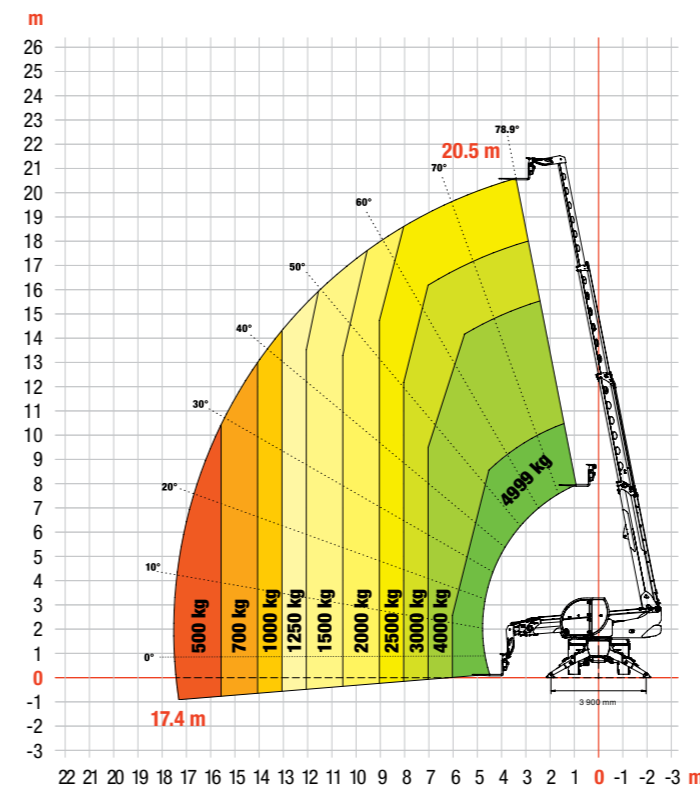

TR50.250

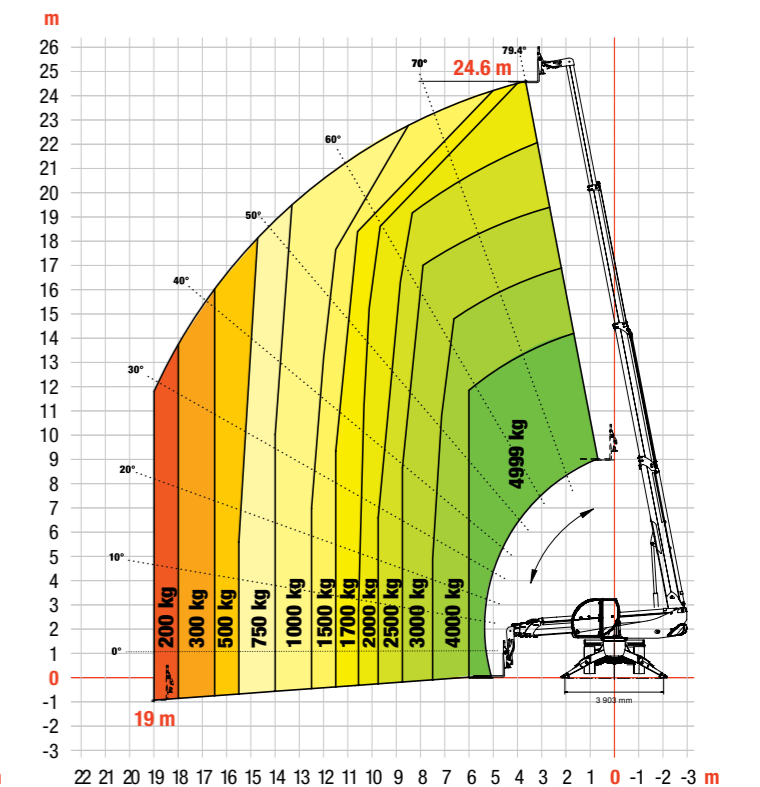

Load charts with load centre at 500 mm up to 4999 kg rated capacity and 600 mm above.

SPECIFICATIONS

SPECIFICATIONS	TR60.210	TR60.250	TR70.260	TR60.300	TR60.350	TR60.390
PERFORMANCE						
Rated capacity at 600 mm load center	6 000 kg		7 000 kg	6 000 kg		
Max. lifting height (stabilizers fully extended)	20.80 m	25 m	25.7 m	29.8 m	34.9 m	38.9 m
Turret rotation	360° (Continuous)					
Frame levelling	+/- 8°					
Max. speed	40 km/h					
STABILIZERS						
Type	Telescopic scissors					
Stabilization system	Ground pressure detection. Automatic levelling. Lifting capacity adjusted in proportion to stabilizer extension					
ENGINE						
Deutz TCD 3.6 L4 - 100 kW (134 HP) - Stage V	•	•				
Volvo TAD 582 VE - 160 kW (218 hp) - Stage V			•	•		
Volvo TAD 582 VE - 175 kW (238 hp) - Stage V					•	•
HYDRAULIC SYSTEM						
Pump type	Load Sensing pump					
Pump capacity	105 l/min at 350 bar			124 l/min at 350 bar		
Control valve (boom and turret)	Electro-proportional with flow sharing					
DRIVE SYSTEM & STEERING						
Transmission	Hydrostatic with electronic regulation / 4 wheel drive					
Main drive	Electronically controlled variable displacement pump. Variable displacement motor. 2-speed gear box					
Steering modes	3 steering modes with semi-automatic wheel realignment. 2 wheel steering / 4 wheel steering / Crab-steer					
DIMENSIONS & WEIGHT						
Overall length at fork face	6.69 m	7.63 m	7.83 m	7.80 m	8.09 m	8.60 m
Overall width at tires	2.53 m	2.53 m	2.54 m	2.53 m	2.54 m	2.54 m
Overall height at roof wiper	3.12 m	3.15 m	3.12 m	3.12 m	3.12 m	3.12 m
Stabilization area (stabilizers fully extended)	5.19 × 5.61 m		5.80 × 6.0 m			
Standard tires	445/65 R22.5					
External turning radius	3.98 m			4.06 m		
Weight (unladen)	17 600 kg	18 000 kg	20 700 kg	21 800 kg	24 000 kg	
FLUID CAPACITIES						
Fuel tank	175 l		270 l			
Adblue	10 l		40 l			
Hydraulic reservoir	165 l		195 l			

▶ FRAME LEVELING ON TIRES



▶ TR60.210

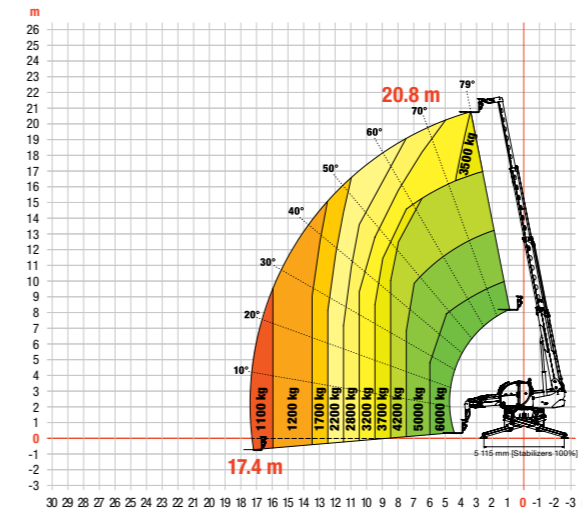

▶ TR60.250

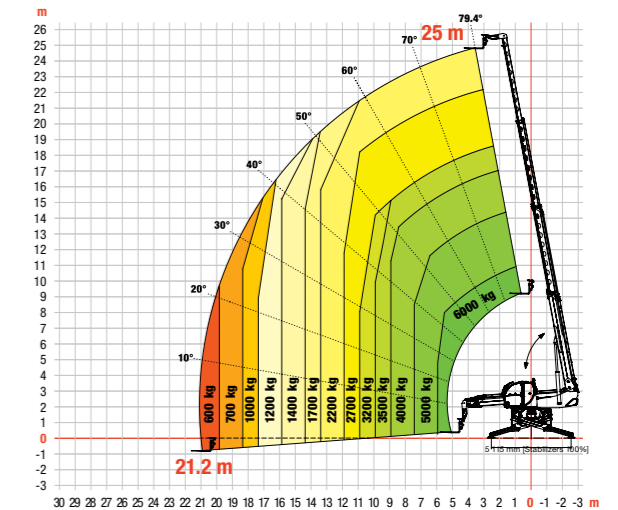

▶ TR70.260

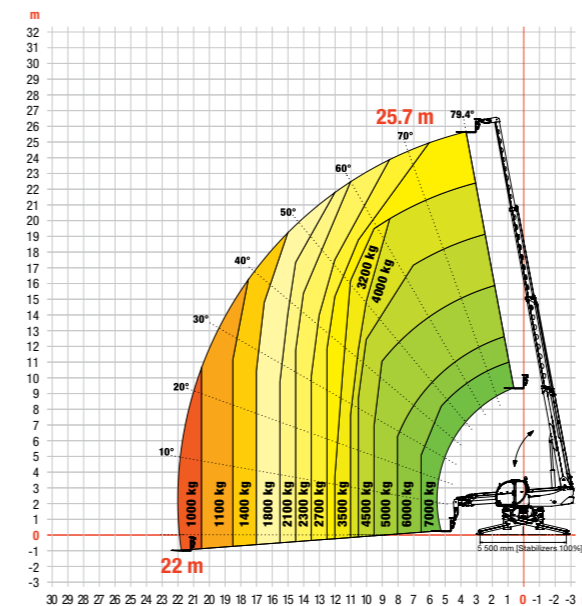

▶ TR60.300

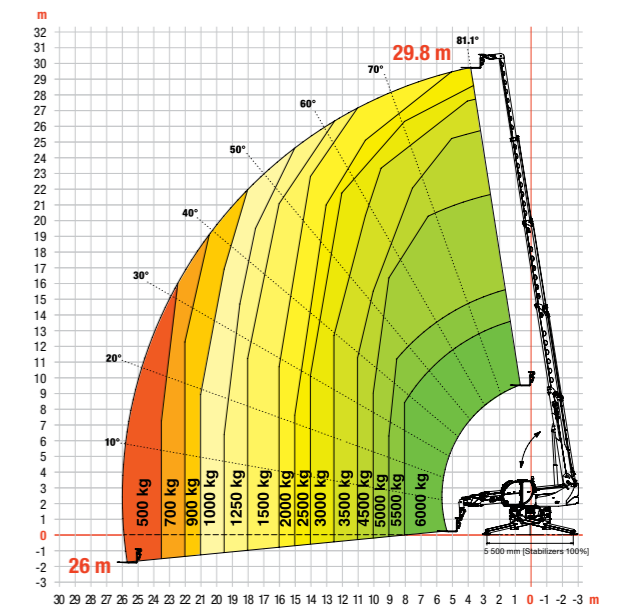

▶ TR60.350

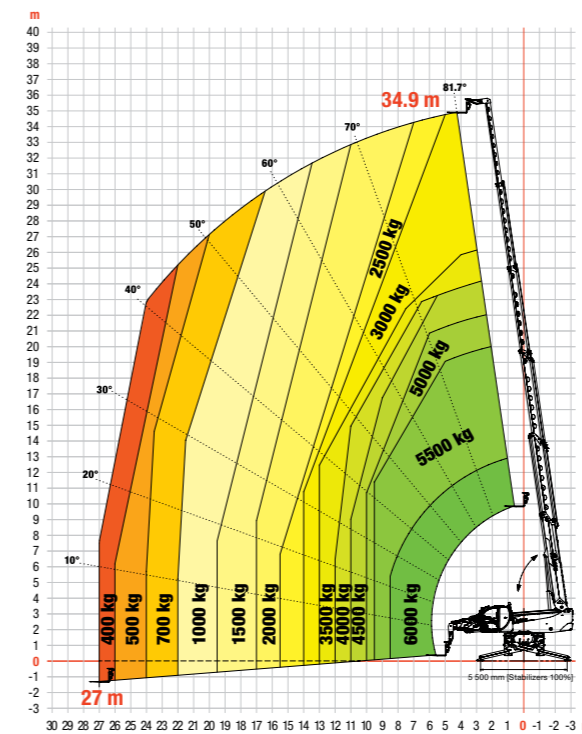

▶ TR60.390

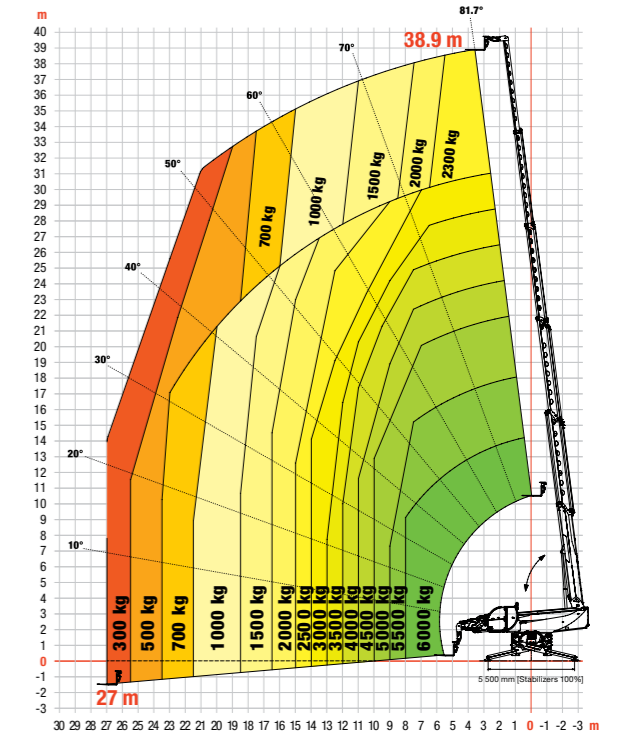



150 ATTACHMENTS 63 MACHINES 1 TOUGH ANIMAL

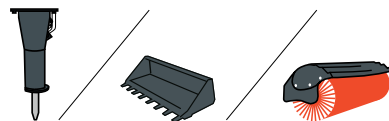

► DESIGNED TO DO MORE

Bobcat offers the widest range of attachments for all your needs in Construction, Landscaping, Agriculture, Road, Material Handling and Forestry.



SKID STEER LOADERS

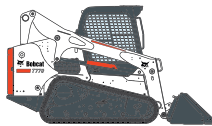

COMPACT TRACK LOADERS



MINI TRACK LOADERS

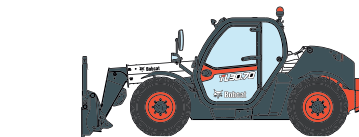

TELEHANDLERS



COMPACT EXCAVATORS

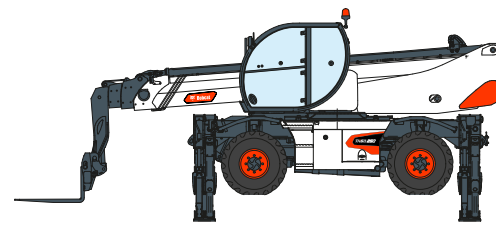
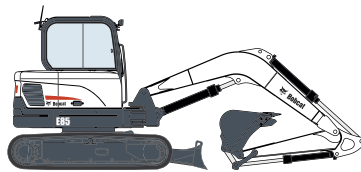

ROTARY TELESCOPIC HANDLERS



Bobcat®

Bobcat is a Doosan Company.

Doosan is a global leader in construction equipment, power & water solutions, engines, and engineering proudly serving customers and communities for more than a century. | Bobcat and the Bobcat logo are registered trademarks of Bobcat Company in the United States and various other countries.
©2021 Bobcat Company. All Rights Reserved.

*Financing options may vary by country and dealer. Always ask your dealer about currently available financing options. Terms and conditions may apply.

